

3 601 B20 100
 Issue } 11-11-14
 Stand }

Fig./Abb. 1

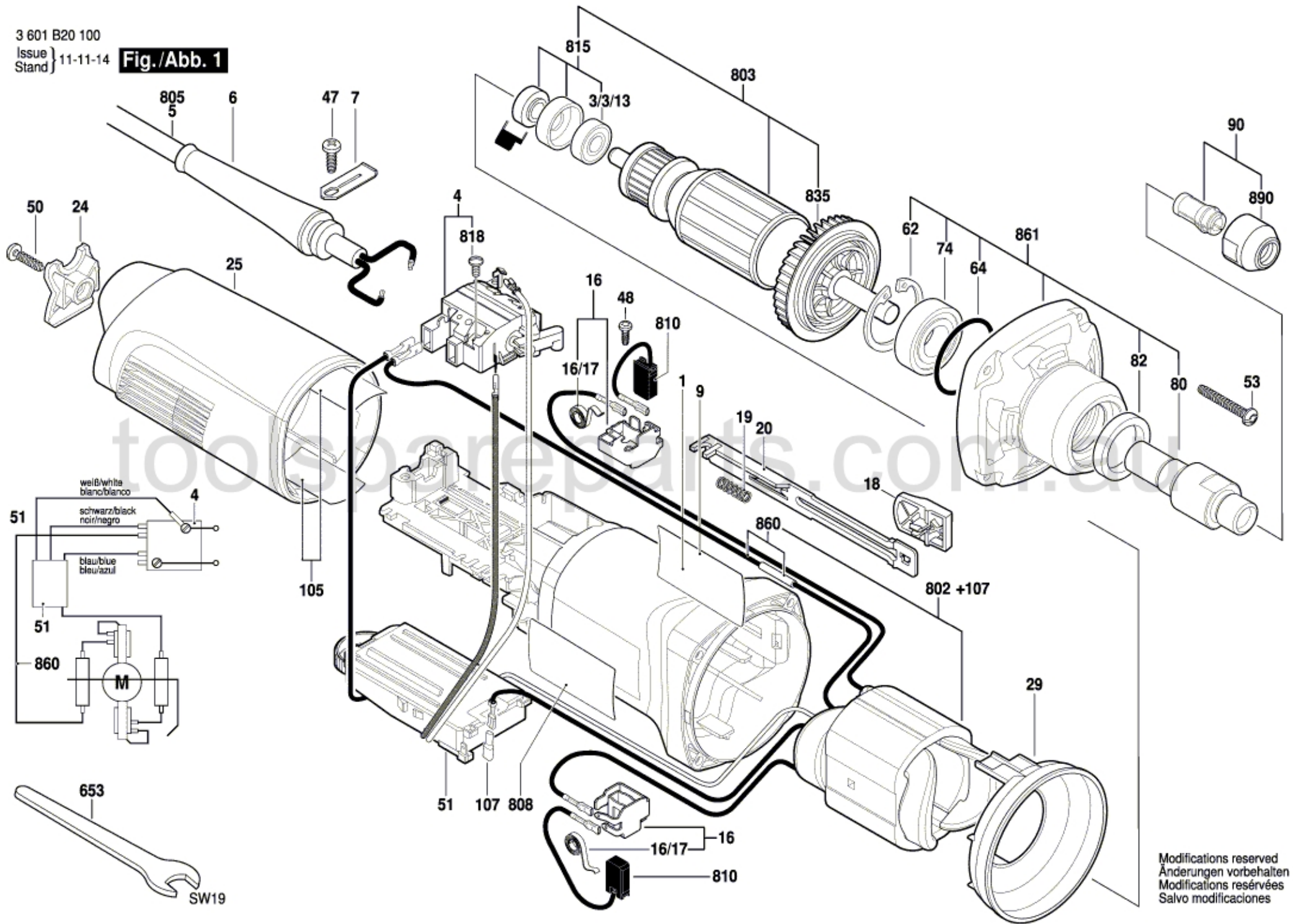

Modifications reserved
 Änderungen vorbehalten
 Modifications réservées
 Salvo modificaciones